

**1** Assemble the junctions.  
Assembler les jonctions.

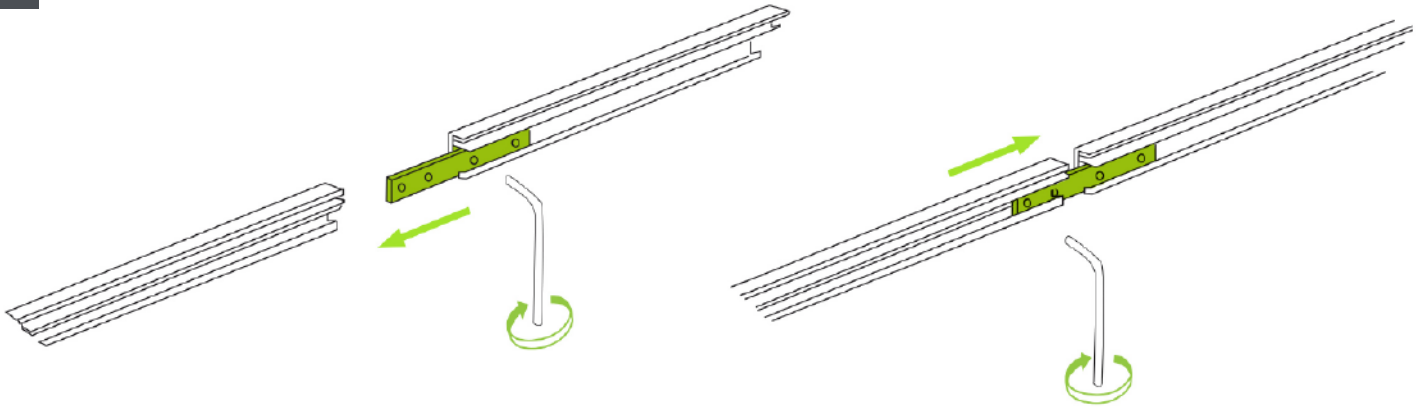

**2** Install the corner brackets.  
Installez les supports d'angle.

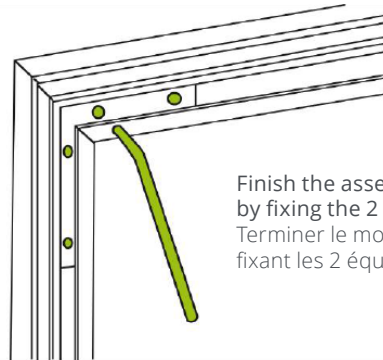
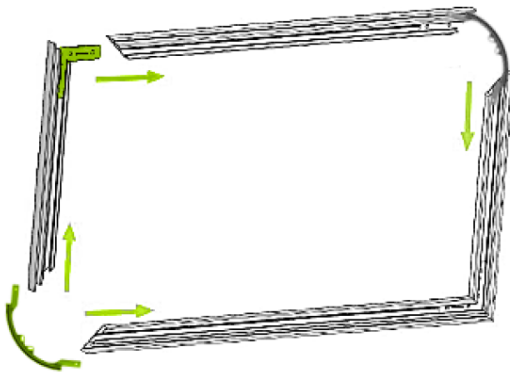

Finish the assembly of the frame on one side by fixing the 2 brackets.  
Terminer le montage d'un coté du cadre en fixant les 2 équerres.

**3** Mount the wall brackets.  
Monter les équerres murales.

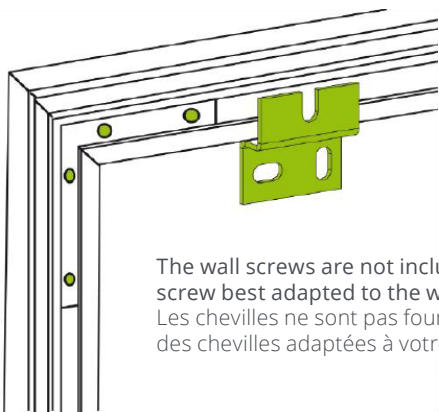

The wall screws are not included. Choose the screw best adapted to the wall type.  
Les chevilles ne sont pas fournies. Choisissez des chevilles adaptées à votre mur.

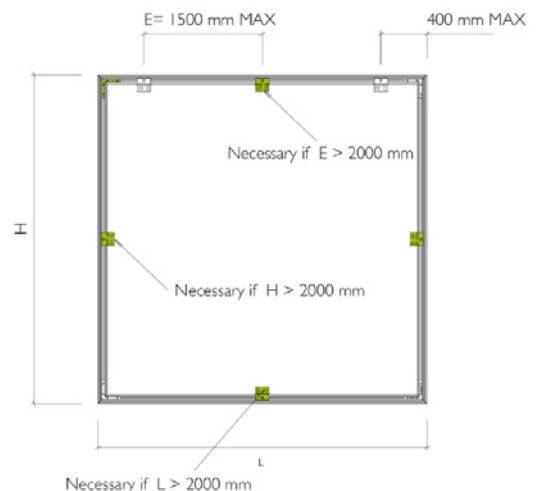

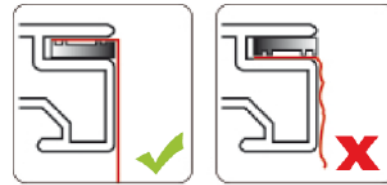
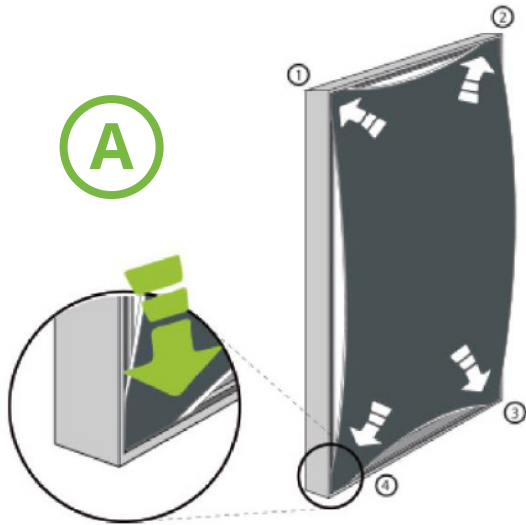

Insert the graphic in the 4 corners of the frame by pushing the silicone edging into the groove. Commencez par les 4 angles.

Insert the silicone edging in the middle of each side of the frame.  
Insérer le joint au milieu du cadre.

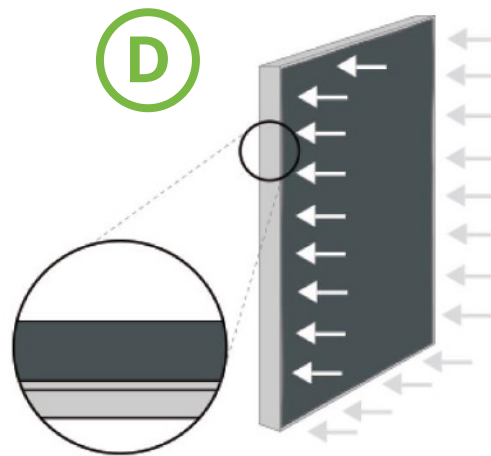
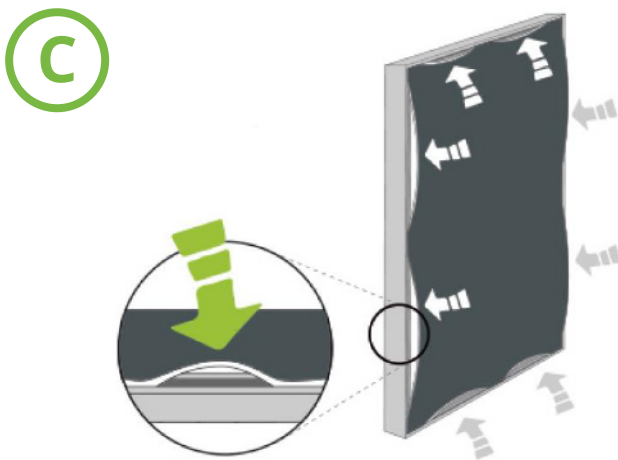
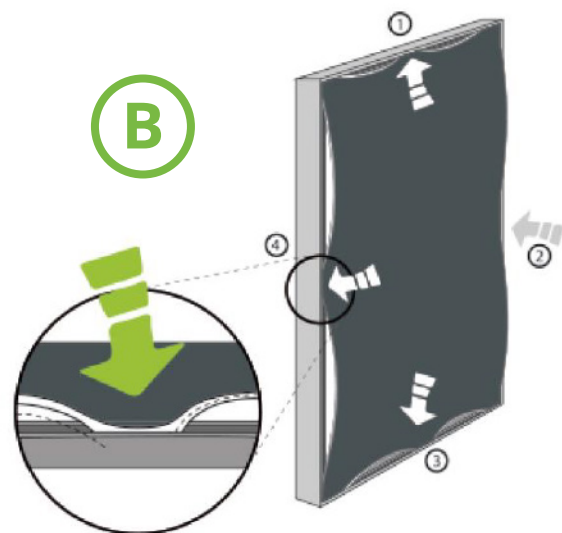

Work outwards towards the corners while continuing to press downwards on the silicone edging. To avoid stretching, creasing at the edges and dirtying the graphic, do not wipe your hands across the image. Puis se diriger vers les extrêmités par petits appuis. Ne pas faire glisser les doigts sur le visuel.